

WAGNER PRESENTS

NORSK

Nyheter 2019

PRODUKTOVERSIKT

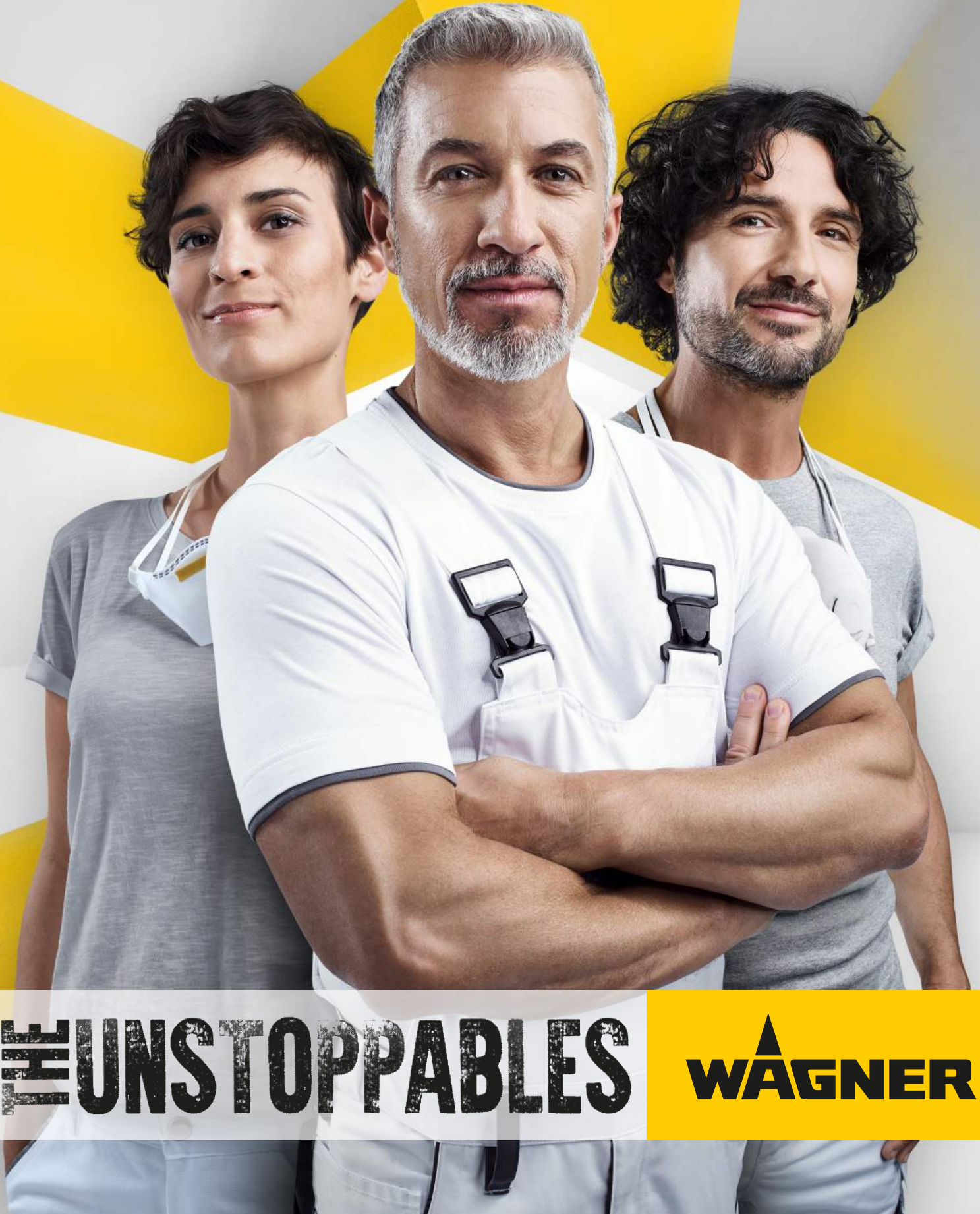

UNSTOPPABLES

WAGNER

HEA - HIGH EFFICIENCY AIRLESS

Opptil 55% mindre sprøytetåke maksimal kontroll

Den nye HEA ProTip Airless-dysen fra WAGNER gir en perfekt overflatekvalitet med redusert spraytrykk. Sammenlignet med standard Airless-teknologi får du en mykere spraystråle, som gir en jevnere overflate uten skarpe kanter. Arbeid uten å bli sliten: Lavtrykkssprøyting gir mindre motstand/rekyl fra pistolen og gjør arbeidet dermed mer komfortabelt og mindre slitsomt. Videre er det mindre behov for å dekke på grunn av redusert sprøytetåke.



Enkel rengjøring

WAGNER HEA-dyser er såkalte svingdyser, som kan rengjøres på sekunder. Sving dyse og sprøyt, og deretter blir dysen rengjort - helt uten bruk av verktøy.

Dysevinkel

Dysevinkelen bestemmer sprøytebildets bredde, her f.eks. vinkel 50°.

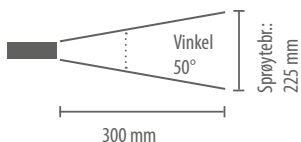

Den ideelle avstanden til underlaget er alltid ca. 300 mm.

Dysediameter

Dysehullets diameter (her 0,017 tommer) bestemmer dermed mengden maling som påføres.

Ekstra lang levetid

Den rustfrie stålsylinderen og karbid-dysene reduserer slitasje og gjør det mulig å få en konstant sprøytevinkel.

GRATIS
MED HVER DYSE



GRATIS: Ved kjøp av HEA-dyse er et passende pistolfilter og en dyseforsegling inkludert.

Praktisk anordning

for enkel installasjon av dysepakken.

Innovativ dobbeldyse-teknologi

Atomiser dyse

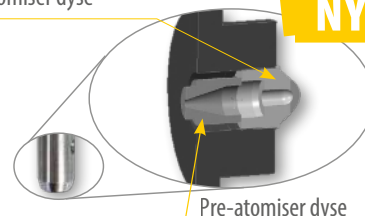

Pre-atomiser dyse

To dyser garanterer et perfekt sprøytebilde - også i lavtrykksområdene kombinert med høy strøm av maling. Sprøytetåken er redusert til et minimum.



OVERSIKT OVER ALLE FORDELENE

1. Mindre sprøytetåke: Det lavere sprøytetrykket gir en reduksjon av sprøytetåke med **opptil 55%**. I tillegg til redusert materialforbruk, minsker behovet for tildekking, spesielt i innendørs prosjekter. Teknologien er dermed mer miljøvennlig og beskytter dessuten øyne og lunger.

2. Maksimal kontroll: Den myke sprøytestrålen gir bedre dekning på overlappende baner og forhindrer skarpe kanter. Så det er ikke alltid nødvendig å rulle over overflaten. Det gir en enkel og lett håndterlig teknikk med "garanti for suksess" - også for uerfarne brukere.

3. Lang levetid: På grunn av det robuste karbidmunnstykkets design og det lave sprøytetrykket avgir dysen mindre støv. Derfor kan HEA-dysene brukes mye lengre enn vanlige luftfrie dyser. Systemets levetid øker også: Det lavere sprøytetrykket gir mindre slitasje på systemet og dets komponenter.

4. Overflatekvalitet: Det høyeffektive Airless systemet gir en homogen og uniform spredning av materialet på alle overflater og gir derfor en forbedret overflatekvalitet sammenlignet med konvensjonell pensel- og rullepåføring.

5. Arbeid uten å bli sliten: Lavtrykksprøyting gir mindre motstand/rekyl i pistolen og er dermed mer komfortabelt og mindre slitsomt.

6. WAGNER Sprøyteguide: I sprøyteGuiden finner du våre eksperter testrapporter på materialer fra navngitte malings- og lakkleverandører, sprøytet med WAGNER sprøyter. SprøyteGuiden oppdateres kontinuerlig. På wagner-group.com/sprayguide finner du svar på hvordan du konfigurerer ditt sprøyteutstyr i henhold til materialet som brukes og hvilken maling og lakk som passer best til vår HEA-dyseteknologi.



Jevn sprøyting uten kanter.



Øk presset sakte på synlige kanter.

1 Forberedelse - fjerning av tapet

SteamForce Pro





















Produktbilde (kan avvike)	
Art. No.	2351453
Kategori	DPPE
Motoreffekt	2.75 kW
Drift	
Spenning	230 V / 50 Hz
Dampladernes størrelse	253 x 305 mm / 140 x 70 mm
Slangelengde	5 m
Tank volum	7,5 l
Damptid max.	90 min
Oppvarmingstid	ca. 18 min
Kabellengde	5 m
Temperaturnivåer	-
Vifte	-
Luft volum	-

2 Mindre prosjekter - sporadisk bruk

NY!

HEA HIGH EFFICIENCY AIRLESS

























HEA HIGH EFFICIENCY AIRLESS

	FinishControl 3500	FinishControl 5000	ControlPro 350 Extra Skid version	ControlPro 350 Extra Cart version	PowerPainter 90 Extra HEA
Sprøytemetode					
Produktbilde (kan avvike)					
Kategori	2341501	2316090	2371061	2371065	2401275
Cat.	DPXVLP	DPXVLP	DPPPE	DPPPE	DPPPE
Teknologi					
Vekt	2.3 kg	8 kg	7.6 kg	13 kg	23 kg
Motoreffekt	0.7 kW	1.4 kW	0.6 kW	0.6 kW	0.8 kW
Drift					
Spennning	230 V / 50 Hz	230 V / 50 Hz	230 V / 50 Hz	230 V / 50 Hz	230 V / 50 Hz
Maks. dysestørrelse	-	-	0.019"	0.019"	0.019"
Maks. driftstrykk	0.2 bar, 0.02 MPa	0.275 bar, 0.0275 MPa	110 bar, 11 MPa	110 bar, 11 MPa	207 bar, 20.7 MPa
Maks. materiale	-	-	1.5 l/min	1.5 l/min	1.3 l/min

Materiale	FinishControl 3500	FinishControl 5000	ControlPro 350 Extra Skid version	ControlPro 350 Extra Cart version	PowerPainter 90 Extra HEA
Dispersjoner, fasade og latexmaling	S	S	S	S	S
Glasing, flekker og impregneringsmidler	S	S	S-M	S-M	S-M
Grunninger, primere, fyllstoffer, syntetiske resinbaserte malinger, akrylmaling	S	S	S-M	S-M	S-M
Emulsjon og latex maling	S	S	S	S	S-M

























Passer for følgende objektstørrelser: S = Mindre enn 200 m², M = 200 m² - 800 m², L = over 800 m², - = Passer ikke

3 Større prosjekter - Innvendige vegger og fasader

	NY! HEA HIGH EFFICIENCY AIRLESS SuperFinish 23 Pro	HEA HIGH EFFICIENCY AIRLESS SuperFinish 23 Plus Emulsion HEA; På vogn	NY! SuperFinish 33 Pro	NY! SuperFinish 33 Plus	Erstattes i Q2 av PS 20 (2403616) HEA HIGH EFFICIENCY AIRLESS ProSpray 3.20 HEA	HEA HIGH EFFICIENCY AIRLESS ProSpray 3.21 HEA
Sprøytemetode						
Produktbilde (kan avvike)						
Art. No.	2399198	2384153	2388260	2388259	2384151	532089
Cat.	DPFSF	DPFSF	DPFSF	DPFSF	DPPS	DPPS
Teknologi						
Vekt	27 kg	29 kg	43 kg	50 kg	13.6 kg	17.9 kg
Motor effekt	1.3 kW	1.3 kW	2.2 kW	2.2 kW	1 kW	1.03 kW
Drift						
Spenning	230 V / 50 Hz	230 V / 50 Hz	230 V / 50 Hz	230 V / 50 Hz	230 V / 50 Hz	230 V / 50 Hz
Maks. dysestørrelse	0.023"	0.023"	0.033"	0.033"	0.021"	0.023"
Maks. driftstrykk	250 bar, 25 MPa	250 bar, 25 MPa	250 bar, 25 MPa	250 bar, 25 MPa	207 bar, 20.7 MPa	221 bar, 22.1 MPa
Maks. materiale	2.6 l/min	2.6 l/min	4.3 l/min	4.3 l/min	1.6 l/min	2 l/min
Maks. viskositet	20.000 mPas	20.000 mPas	25.000 mPas	25.000 mPas	20.000 mPas	20.000 mPas

Materiale	SuperFinish 23 Pro	SuperFinish 23 Plus Emulsion	SuperFinish 33 Pro	SuperFinish 33 Plus	ProSpray 3.20 HEA	ProSpray 3.21 HEA
Dispersjoner, fasader og lateks	S-M	S-M	M-L	M-L	S	S
Tekstil lim (interiør)	-	-	M-L	M-L	-	-

Passer for følgende objektstr.: S = Mindre enn 200 m², M = 200 m² - 800 m², L = over 800 m², - = passer ikke

ProSpray 3.25	ProSpray 3.29	ProSpray 3.31	ProSpray 3.34	ProSpray 3.39 Emulsion	HeavyCoat 950
(A) = På bæleramme (B) = På vogn					(E) = Elektrisk (G) = Bensin
					
					
(A) = 2308259 (B) = 2308260	2308261	2308262	2308263	2351261	(E) = 2332184 (G) = 2332186
DPPS	DPPS	DPPS	DPPS	DPPS	DPHC
					
(A) = 17.9 kg (B) = 27.4 kg	43.5 kg	43.5 kg	47.6 kg	50 kg	(E) = 83 kg (G) = 76 kg
1.1 kW	1.72 kW	1.84 kW	1.95 kW	2.19 kW	(E) = 3.6 kW (G) = 4.1 kW
					
230 V / 50 Hz	230 V / 50 Hz	230 V / 50 Hz	230 V / 50 Hz	230 V / 50 Hz	230 V / 50 Hz
0.027"	0.029"	0.032"	0.034"	0.039"	0.052"
221 bar, 22.1 MPa	221 bar, 22.1 MPa	221 bar, 22.1 MPa	221 bar, 22.1 MPa	221 bar, 22.1 MPa	250 bar, 25 MPa
2.6 l/min	3 l/min	3.8 l/min	4.5 l/min	5 l/min	(A) = 6.6 l/min (B) = 8 l/min
25.000 mPas	25.000 mPas	25.000 mPas	25.000 mPas	30.000 mPas	50.000 mPas

ProSpray 3.25	ProSpray 3.29	ProSpray 3.31	ProSpray 3.34	ProSpray 3.39 Emulsion	HeavyCoat 950 E/G
S-M	S-M	M-L	M-L	M-L	M-L
-	S	S-M	M-L	M-L	M-L

SuperFinish 23 Pro



Særdeles brukervennlig membranpumpe til enhver oppgave – fremragende ytelse til inne- og utendørs bruk

- **Nyskapende HEA-teknologi:** Opptil 55% mindre overspray med maksimal kontroll.
- **Fleksibel sugeslange:** Membranpumpe trekker materialer som dispersjoner, latexmaling eller lakk direkte fra originalemballasjen.
- **Lett å flytte:** SuperFinish 23 Pro, med sin sammenleggbare ramme, er ideell for enkel og plassbesparende transport på byggeplassen.
- **Utmerket pålitelighet takket være membranpumpeteknologi:** Praktisk talt vedlikeholdsfri, fungerer pålitelig og lenge, og kan brukes selv med små mengder materiale.

Super kvalitet på sprøyteflaten

Med Vector Pro Sprøyte Pistol. Lett i vekt og lang holdbarhet.

Fleksibel sugeslange

For direkte innsug fra beholder. Problemfritt arbeid takket være det spesielle sugefilteret med meget fine masker.

HEA Trykkmåler

Gjør det mulig å kontrollere trykket på sprøytemaskinen. HEA-dyser gjør det mulig å arbeide i lavtrykksområdet (ideelt på 80 - 140 bar) som er merket med grønt på trykkmåleren.



NY!

Ryddig

Slanger kan enkelt stues bort takket være det integrerte opphenget.

Bekvemmelig

Høyde-justerbart håndtak tillater praktisk transport og lite plasskrevende lagring.

Uendelig regulering av trykk

Fra 0 til 25 MPa

Bruk ulike materialer med QLS long-stroke technology

Mulig grunnet optimalisert hydraulikk og spesiell ventil-teknologi.

Robust design

Med solide hjul er SF 23 Pro den perfekte partner på enhver byggeplass.

Består av

SUPERFINISH 23 PRO SPRAYPACK

Basis enhet SF 23 Pro på vogn	2399 197
HP slange DN6; 25 MPa; NPSM 1/4"; 15m	2390 608
suge-slange opplegg. (returslange og filter inkludert)	2393 123
Airless Vector Sprøyte-pistol; 1/4"; inkl. TradeTip 3 dyse holder; med 4-finger avtrekker	0538 040
HEA ProTip; 519	0554 519
HEA trykkmåler sett	0252 475
Verktøy-sett; inkl. skiftenøkkel 41mm/22mm/19mm og skrutrekker	2390 620

Artikkel nr.

2399 198

Kat.

DPFSF

PRAKTISK TILBEHØR

Airless Sprøyte-pistoler Artikkel Nr.

Airless Vector Pro Sprøytepistol; 1/4"; inkl. TradeTip 3 dyseholder; med 2-finger avtrekker 0538 041

Airless Vector Pro Sprøytepistol; 1/4"; inkl. TradeTip 3 dyse holder; med 4-finger avtrekker 0538 040

Airless Vector Grip Sprøytepistol; 1/4"; inkl. TradeTip 3 dyse holder; med 2- og 4-finger avtrekker 0538 043

Airless Slange Artikkel Nr.

HP slange DN3, 27 MPa, NPS 1/4", 7,5 m 9984 583

AirCoat tilbehør Article No.

AirCoat sprøytepistol AC 4500, blue air cap og holder 2368 269

HP dbl. slange, matr. DN3, maks. 27 MPa, luft DN6, 1/4", 7,5 m 9984 564

AirCoat regulator, tilpasningskit 0340 250

Annet Artikkel Nr.

5 liter hopper, M36x2 0341 265

Trykkmåler-sett. HEA(MPa) 2383 995

Dyser HEA ProTip 0554 XXX

Dyser TradeTip 3 0553 XXX

InlineRoller 345 010

Dyse forlenger 15 cm 556 074

Dyse forlenger 30 cm 356 075

TipClean 2400 214

TempSpray H 126 Spraypack; 10 m 2311 852

ANBEFALTE MATERIALER

Materiale	opp til 200 m ²	200 m ² - 800 m ²
Løsemidler og oljer	✓	✓
Grunninger, primere, fyllemidler, syntetisk, resin basert maling, akrylmaling	✓	✓
Emulsjonsmaling, latex maling	✓	✓

TEKNISKE DATA

Spenning	230 V / 50 Hz
Motor effekt	1.3 kW
Maks. driftstrykk	25 MPa (250 bar)
Maks. materiale	2.6 l /min
Vekt	27 kg
Maks. dysestørrelse	0,023"
Maks. viskositet	20.000 mPas



SuperFinish 33 Pro



Membranpumpe til enhver oppgave – fremragende ytelse til inne- og utendørs bruk

- **Allsidig bruk:** SuperFinish 33 Pro kan behandle et bredt spekter av materialer i mange forskjellige bransjer og prosjektstørrelser.
- **Høy effektivitet og produktivitet:** Med en materialmengde opptil 4,3 liter pr. min. SuperFinish 33 Pro er den kraftigste WAGNER membranpumpen i håndverkssegmentet.
- **Quality LongStroke Technology (QLS):** For lang levetid, lett vedlikehold og minimal slitasje.
- **Praktisk flerpistol-betjening:** For samtidig bruk av flere pistoler er det et adapter for tilkobling av opptil tre luftfrie pistoler som ekstrastyr.



Består av

	Artikkel nr.	Kat.
SUPERFINISH 33 PRO SPRAYPACK	2388 260	DPFSF
SuperFinish 33 Pro basisenhet	2374 595	
Suge-slange system; fleksibel	34 630	
HD slange DN6 PN270 1/4" NPSM 15 m	9984 574	
Vector Pro Airless sprøyte-pistol; 1/4"; inkl. TradeTip 3 dyseholder; med 4-finger avtrekker	0538 040	
TradeTip 3 dyse 523 inkl. hvitt filter	553 523	

SuperFinish 33 Plus



Membranpumpe til enhver oppgave, meget enkel i bruk – fremragende ytelse til inne- og utendørs bruk

- **Allsidig bruk:** SuperFinish 33 Plus kan behandle et bredt spekter av materialer i mange forskjellige bransjer og prosjektstørrelser.
- **Høy effektivitet og produktivitet:** Med en materialmengde opptil 4,3 liter pr. min. SuperFinish 33 Plus er den kraftigste WAGNER membranpumpen i håndverkssegmentet.
- **Quality LongStroke Technology (QLS):** For lang levetid, lett vedlikehold og minimal slitasje.
- **Praktisk flerpistol-betjening:** For samtidig bruk av flere pistoler er det et adapter for tilkobling av opptil tre luftfrie pistoler som ekstrastyr
- **Fleksibel bruk:** Bytt fra arbeid med topp beholderen til fast sugesystem med fine filtermasker på et øyeblikk.
- **Unik multifunksjonsbryter:** For på / av, sirkulasjon og sprøytefunksjon. Dette forhindrer utilsiktet på/avslåing mens systemet er under trykk.
- **Integrert 230 V uttak:** Praktisk for tilkobling av ekstrastyr, for eksempel WAGNER TempSpray.

Ergonomisk arbeid

med kvalitetspistolen Airless Vector Grip. Den er lett, robust og veldig ergonomisk.

Moduloppbygde varianter

Vogn med to innstillinger - bruk med beholder eller rigid sugesystem



NY!

Solide, byggeglassvennlige gummihjul

sikrer enkel transport selv over de mest ujevne underlag.

Integrert verktøykasse

inkl. praktisk oppbevaringsboks. Verktøy og tilbehør er alltid lett tilgjengelig.



Inkluderer praktisk 230 V uttak

for tilkobling av ekstrastyr, f.eks. Temp Spray



Høy driftssikkerhet

takket være inngangsventil-knappen. Trykk med tommelen og ventilen er fri.

Opplyst multifunksjonsbryter for bedre sikkerhet

Flere trinn: På / av bryter gir også sirkulasjon og sprøytefunksjon. Dette forhindrer utilsiktet på/avslåing mens systemet er under trykk.

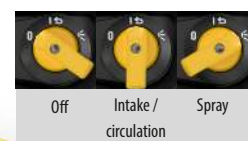

Direkte suging

fra beholderen. Arbeid uten avbrudd takket være det spesielle sugefilteret med veldig fine masker.

Består av

SUPERFINISH 33 PLUS SPRAYPACK

SuperFinish 33 Plus basisenhet	2374 594
Suge-slange system; rigid; D38	2370 310
HD slange DN6; maks. 27 MPa; NPSM 1/4"; 15 m	9984 574
Vector Grip Airless sprøyte-pistol; 1/4"; inkl. TradeTip 3 dyse holder; med 2 og 4-finger avtrekker	0538 043
2 hastighets Tip dyse D20 115/421	0271 046

Artikkel nr.

2388 259

Kat.

DPFSF

SuperFinish 33

PRAKTISK TILBEHØR

Anbefalt tilbehør til SuperFinish 33 familien	Art. Nr.
Beholder sett, 5 liter; M36x2 (01)	0341 265
Beholder sett, 20 liter; M36x2	0341 266
PumpRunner (02) *	2306 987
Dyse forlenger, 15 cm, G-gjenge, med holder uten dyse	0556 074
Slange trommel HR30; M16x1.5	2392 523

* kompatibel med SuperFinish 33 Plus

Airless pistol-sprøyter	Art. Nr.
Vector Pro; 1/4"; inkl. TradeTip 3 dyse holder; med 4-finger avtrekker	0538 040
Vector Pro; 1/4"; inkl. TradeTip 3 dyse holder; med 2-finger avtrekker	0538 041
Vector Grip; 1/4"; inkl. TradeTip dyse holder; med 2 og 4-finger avtrekker (03)	0538 043
Vector Infinity; G gjenge 1/4"; inkl. TradeTip 3 dyse holder; med 2-finger avtrekker (04)	0538 085
AG 14; G gjenge 1/4"; inkl. TradeTip 3 dyse holder	0502 081A

Airless slanger (05)	Art. Nr.
HD slange DN3; max. 27 MPa; NPS 1/4"; 7,5 m	9984 583
HD slange DN6; max. 27 MPa; NPS 1/4"; 15 m	9984 574
HD slange DN6; max. 27 MPa; NPS 1/4"; 30 m	9984 575
HD slange DN10; max. 25 MPa; 3/8" NPSM; 15 m	2336 583

Airless dyser	Art. Nr.
2SpeedTip dyser (06)	0271 XXX
TradeTip 3 dyser (07)	0553 XXX
HEA ProTip dyser (08)	0554 XXX

Sprøyte-pistol push-in filter (09)	Art. Nr.
Pistolfilter gul, 10 stk., 100 MA, 0.14 mm MW, fine	0097 023
Pistolfilter rød, 10 stk., 180 MA, 0.084 mm MW, extra fine	0097 022
Pistolfilter hvit, s10 stk., 50 MA, 0.31 mm MW, medium	0097 024

AirCoat tilbehør	Art. Nr.
AirCoat pistol AC 4500, blå luftkappe og holder (10)	2368 269
HP tvillingslange, materiale DN3, maks. 270 bar, luft DN6, 1/4", 7,5 m	9984 595
AirCoat regulator, påbygnings-sett	0340 250
AirCoat dyser ACF3000 (11)	0379 XXX

Annet	Art. Nr.
InlineRoller i plastkasse, inkl. HT-slange DN4, maks. 270 bar, 7,5 m, 0,5 m forlenger, fargevalse av vevet plysj med 13 mm luv, m.m. (12)	0345 010
Fordelingsadapter for maks. 3 pistoler	2304 430
Dobbelt kobler A = 1/4" x 1/4"	34 038
Overgangskobling I = 1/4"NPSM x A = 3/8"NPSM; 27 MPa	179 732

TEKNISKE DATA

	SF 33 Pro	SF 33 Plus
Motor effekt	2.2 kW	2.2 kW
Spennning	230 V/50 Hz	230 V/50 Hz
Maks. driftstrykk	25 MPa (250 bar)	25 MPa (250 bar)
Maks. materiale	4.3 l/min	4.3 l/min
Fødemengde ved 12 MPa sprøytetrykk	3.8 l/min	3.8 l/min
Max. dysestørrelse	0.033"	0.033"
Vekt	43 kg	50 kg
Suge-slange system	flexible	rigid
To-stillings vogn	–	✓
Multifunksjons bryter	–	✓
Integrert støpsel	–	✓

3 GRUNNER TIL Å VELGE EN MEMBRANPUMPE

1. Opptil 58% mindre materiale i systemet: De små diametrene i anlegget gjør at membranpumpen kan virke med svært små mengder materiale. Det sparer materiale - både ved utskifting av materialer og rengjøring. Enklarfordel sammenliknet med konvensjonelle stempelpumper.

2. Minimalt vedlikehold: Membranpumper krever nesten ikke vedlikehold. Membranen er holdbar og fungerer pålitelig. Sammenliknet med en stempelpumpe er det opptil 50% kostnadsbesparelser i forbindelse med vedlikehold. Hvis en reparasjon fortsatt er nødvendig, kan deler enkelt byttes på stedet.

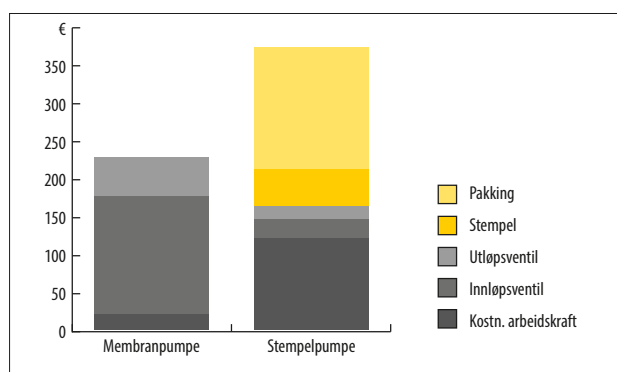

3. Lav pulsering: Membranteknologien gjør det mulig å oppnå et meget fint og jevnt sprøytebilde. Membranets kortere slag reduserer pulseringen og dermed unngår man uregelmessigheter i sprøytebildet. Det ekstra tilkoblingspunktet til stemplet er ikke tilstede i en membranpumpe.

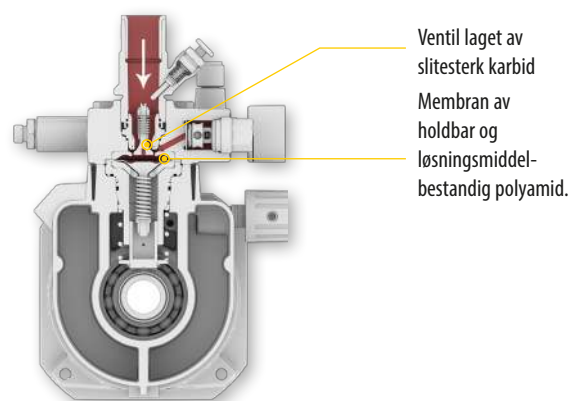

Fig.: Ved lavt trykk: Membranpumpen har jevn sprøytestråle (gul) og stempelpumpen har uregelmessig sprøytestråle (blå).

KRAFTIG, ROBUST QLS TEKNOLOGI

Hvis du vil bruke mange ulike materialer med kun én sprøyte, er membranpumpen det beste valget. Quality Long Stroke Technology fra WAGNER (QLS-teknologi), Airless membranpumper er effektive, servicevennlige og gir den beste overflatekvaliteten. Optimalisert Hydraulikk og spesiell ventilteknologi sikrer enda bedre ytelse.





















Membranets lengre slag gjør det mulig å behandle et meget bredt utvalg av materialer, fra tynn til høy viskositet. På grunn av den reduserte slagfrekvensen, blir delene utsatt for betydelig mindre slitasje. Det betyr lengre levetid og lavere vedlikeholdskostnader.



Designet av membranen gir en jevn bevegelse. Dette gjør membranen stabil og pålitelig.



























4 Store prosjekter - gips, sprøytesparkel og bitumen

	ProSpray 3.39 Filler	HeavyCoat 750 (E) = Elektrisk (G) = Bensin	HeavyCoat 750 E SSP	HeavyCoat 950 (E) = Elektrisk (G) = Bensin	HeavyCoat 970 (E) = Elektrisk (G) = Bensin
Sprøyte metode					
Produktbilde (Kan avvike)					
Art. Nr.	2308264	(E) = 2371027 (G) = 2371029	2371028	(E) = 2332184 (G) = 2332186	(E) = 2332191 (G) = 2332192
Kat.	DPPS	DPHC	DPHC	DPHC	DPHC
Teknologi					
Vekt	50 kg	(E) = 85 kg (G) = 81 kg	86 kg	(E) = 83 kg (G) = 76 kg	(E) = 100 kg (G) = 88 kg
Motor effekt	2.19 kW	(E) = 3.1 kW (G) = 4.1 kW	3.1 kW	(E) = 3.6 kW (G) = 4.1 kW	(E) = 5.5 kW (G) = 6 kW
Drift					
Spenning	230 V / 50 Hz	230 V / 50 Hz	230 V / 50 Hz	(E) = 230 V / 50 Hz	(E) = 400 V / 50 Hz
Maks. dysestørrelse	0.039"	0.043"	0.043"	0.052"	0.056"
Maks driftstrykk	221 bar, 22.1 MPa	250 bar, 25 MPa	250 bar, 25 MPa	250 bar, 25 MPa	250 bar, 25 MPa
Maks. materiale	5 l/min	(E) = 6 l/min (G) = 7.6 l/min	6.0 l/min	(E) = 6.6 l/min (G) = 8 l/min	(E) = 10 l/min (G) = 12 l/min
Maks. viskositet	30.000 mPas	(E) = 50.000 mPas (G) = 65.000 mPas	50.000 mPas	50.000 mPas	65.000 mPas
Maks. kornstørrelse	-	-	-	-	-

Materiale	ProSpray 3.39 Filler	HeavyCoat 750 E/G	HeavyCoat 750 E SSP	HeavyCoat 950 E/G	HeavyCoat 970 E/G
Brannhemmende materiale, rustbeskyttelse, tekstillim	S	M	M	M	L
Airless sprøyte- sparkel	S	M	M	M	L
Tetting av bygninger (maling med bitumen og tykk, dekkende maling)	-	M	M	M	L
Gips (penselstrøk / betong primer, siste strøk)	-	-	-	-	-
Armeringssparkel, WDVS-lim / sparkelmasse, mineralisk gips	-	-	-	-	-

Passer for følgende objektstr.: S = mindre enn 200 m², M = 200 m² - 800 m², L = over 800 m², - = passer ikke

NY!

HeavyCoat 950 SSP (E) = Elektrisk (G) = Bensin	HeavyCoat 970 SSP (E) = Elektrisk (G) = Bensin	PlastCoat 830 E	PlastCoat 1030 E	PlastMax	PlastCoat HP 30
					
					
(E) = 2332187 (G) = 2332189	(E) = 2332193 (G) = 2332194	2308305	2361588	2361587	2388301
DPHC	DPHC	DPPC	DPPC	DPPC	DPPC
					
(E) = 84 kg (G) = 76 kg	(E) = 103 kg (G) = 88 kg	47 kg	59 kg	178 kg	72 kg
(E) = 3.6 kW (G) = 4.1 kW	(E) = 5.5 kW (G) = 6 kW	1.8 kW	2.2 kW	3.0 kW	2.3 kW
					
(E) = 230 V / 50 Hz	(E) = 400 V / 50 Hz	230 V / 50 Hz	230 V / 50 Hz	230 V / 50 Hz	230 V / 50 Hz
0.052"	0.056"	-	-	-	0.055"
250 bar, 25 MPa	250 bar, 25 MPa	40 bar, 4 MPa	40 bar, 4 MPa	40 bar, 4 MPa	120 bar / 12 MPa
(E) = 6.6 l/min (G) = 8 l/min	(E) = 10 l/min (G) = 12 l/min	12 l/min	15 l/min	15 l/min	>10 kg/min
50.000 mPas	65.000 mPas	-	-	-	-
-	-	K3 mm	K6 mm	K6 mm	-

HeavyCoat 950 E/G SSP	HeavyCoat 970 E/G SSP	PlastCoat 830 E	PlastCoat 1030 E	PlastMax	PlastCoat HP 30
M	L	S-M	M-L	M-L	M-L
M	L	S-M	M-L	-	M-L
M	L	S-M	M-L	M-L	-
-	-	S-M	M-L	M-L	-
-	-	S-M	M-L	M-L	-

PlastCoat HP 30



Det beste av to teknologier - robust skruerpumpe med Airless teknologi for tyktflytende materialer.

- **Enkel betjening:** Det brukervennlige kontrollpanelet for styring av rotor og stator muliggjør problemfri bruk - også for uerfarne brukere. Den ergonomiske Airless pistolen og høytrykksslangen sikrer enkel håndtering og gjør systemet ekstra brukervennlig.
- **Maksimal ytelse:** PlastCoat HP 30 er overbevisende med en tilførselshastighet på maks. 10 kg / min. I tillegg kan sprøytetrykket justeres trinnløst mellom 40-120 bar.
- **Høy pålitelighet og velprøvd teknologi:** Høy pålitelighet og velprøvd teknologi: Skrupumper er robuste og har minimal slitasje og vedlikehold. Og med Airless-sprøyteteknikken oppnås en meget høy overflatekvalitet.
- **Fleksibel bruk:** Ved behov kan skruerpumpen raskt omgjøres til bruk med dispersjonsmaling med HEA-teknologi. (Krever ekstra tilbehør)
- **Støysvak sparkling for full styrke:** PlastCoat HP 30 muliggjør støysvak og behagelig Airless-sprøyting uten ekstra kompressor med et driftstrykk på opp til 120 bar..

Kraftig sprøyte-pistol
Airless pistol AG 19 behandler tyktflytende materialer uten problemer.

Fargeavstemt trykkmåler
Tillater tilpasning av trykket optimalt for det aktuelle materialet.

Materialbeholder i plast
Enkel å rengjøre med en kapasitet på 50 liter. Toppdeksel for beholderen er tilgjengelig som ekstrautstyr. (Art. No. 2400 030).

Kompakt størrelse
Med en høyde på 62 cm, er det enkelt å fylle beholderen.

Enkel håndtering
Takket være det brukervennlige kontrollpanelet.

Perfekt for enhver byggeplass
De store luftgummihjulene sikrer mobilitet på enhver byggeplass.

Lydsvak og komfortabel airless sprøyting
med et arbeidstrykk på opp til 120 bar uten ekstra kompressor

Enkel å konvertere til dispersjonsarbeid
Med dispersjonspakken som består av 15 m slange (DN 10) og Vector Pro Sprøyte-pistol med HEA dyse 517.

HEA HIGH EFFICIENCY AIRLESS

NY!

Består av	Artikkel nr.	Kat.
PLASTCOAT HP 30 SPRAYPACK	2388 301	DPPC
Basisenhet, PC HP 30	2383 783	
HP slange Ø19, 10 m	2390 763	
HP whip slange, DN10, 2.5 m	2390 762	
Airless Sprøyte-pistol AG 19; 25 MPa; G-gjenge 3/8"; inkl. TradeTip 3 dyse holder	2341 127	
TradeTip 3 dyse 443	553 443	
PlastGuard Longlife konserveringsmiddel, 5 liter	2399 960	

DISPERSJON



Art. Nr.

Inkludert i PlastCoat HP 30 derspersjons-sett:	2400 684
Airless Sprøyte-pistol Vector Pro; 1/4"; inkl. TradeTip 3 dyse holder med 4-finger avtrekker	538 040
HP slange DN10; maks. 25 MPa; NPSM 3/8"; 15 m	2336 583
HEA ProTip dyse 517	554 517
Adapter FM 1/2BSPP-3/8NPSM	2332 623
Adapter FM 1/4 NPSM-3/8NPSM	179 732

PRAKTISK TILBEHØR

Slanger	Art. Nr.
HP slange Ø19, 10m	2390 763
HP avlastningsslange, DN10, 2.5m	2390 762
HP slange DN10; maks. 25 MPa; NPSM 3/8"; 15 m	2336 583
Sprøyte-pistoler og dyser	Art. Nr.
Airless Sprøyte-pistol AG 19; 25 MPa; G-gjenge 3/8"; inkl. TradeTip 3 dyseholder	2341 127
Airless Sprøyte-pistol Vector Pro; 1/4"; inkl. TradeTip 3 dyseholder med 4-finger avtrekker	538 040
TradeTip 3 dyser	0553 XXX
HEA ProTip dyser	0554 XXX
Dyseholder; G-gjenge 7/8"; for TradeTip 3 dyser	0289 390
Annet	Art. Nr.
Dyse forlenger, 30 cm, G-gjenge, med holder uten dyse	556 075
Dyseforlenger, 60 cm, G-gjenge, med holder uten dyse	556 077
Rengjøringskule DN12	2402 355
Rengjøringskule DN19	342 330
Rotor og stator; komplett for PlastCoat HP 30	2395 996
Toppdeksel for materialbeholder i plast	2400 030
Rullebord med sekkevalse	2389 048
PlastGuard konserveringsmiddel, 1 liter	2399 959
PlastGuard longlife konserveringsmiddel, 5 liter	2399 960

ANBEFALTE MATERIALER

	Up to 200 m ²	200 m ² -800 m ²	Over 800 m ²
Vannbasert grunning	✓	✓	✓
Uten- og innendørs vannbasert dispersjonsmaling.	✓	✓	✓
Tekstillim, vegg og takmaling	✓	✓	✓
Dispersjons sparkel	✓	✓	✓
Airless sprøytesparkel	✓	✓	✓
Mineralsk sparkel og fyllstoffer	✓	✓	✓









TEKNISKE DATA

Vekt	72 kg
Motoreffekt	2.3 kW
Spenning	230 V/50 Hz
Maks. driftstrykk	120 bar, 12 MPa
Maks. materiale (airless dispersion sprøyte-sparkel)	> 10 kg / min
Maks. transporthøyde	20 m
Maks. aksjonsradius	22.5 m
Maks. kornstørrelse	0.3 mm

* Airless sprøyte-sparkel, dispersjons-sparkel













5 Byggeglass–Temperaturkontrollert sprøyting

	TempSpray H 126 basisenhet	TempSpray H 126 Spraypack	TempSpray H 226 basisenhet	TempSpray H 226 Spraypack	TempSpray H 326 basisenhet
Sprøytemetode	-		-		-
Produktbilde (kan avvike)					
Art. Nr.	2311659	2311852	2311660	2311853	2311661
Kat.	DPTS	DPTS	DPTS	DPTS	DPTS
Teknologi	-	-	-	-	-
Vekt	3.2 kg	3.2 kg	13.2 kg	13.2 kg	16.8 kg
Drift					
Spenning	230 V / 50 Hz	230 V / 50 Hz	230 V / 50 Hz	230 V / 50 Hz	230 V / 50 Hz
Strømkabel	4 m	4 m	6 m	6 m	6 m
Varmeeffekt	0.6 kW	0.6 kW	1.3 kW	1.3 kW	1.1 kW
Slangelengde	10 m	10 m	15 m	15 m	30 m
Maks. driftstrykk	250 bar, 25 MPa	250 bar, 25 MPa	250 bar, 25 MPa	250 bar, 25 MPa	250 bar, 25 MPa
Temperaturregulator	20 – 60 °C	20 – 60 °C	20 – 60 °C	20 – 60 °C	20 – 60 °C
Maks. viskositet	5.000 mPas	5.000 mPas	25.000 mPas	25.000 mPas	25.000 mPas





















Materiale	TempSpray H 126 basisenhet	TempSpray H 126 Spraypack	TempSpray H 226 basisenhet	TempSpray H 226 Spraypack	TempSpray H 326 basisenhet
Trebeskyttelse, olje, beis, lasyr, primer, grunning, fyllstoff lakk	+	+	-	-	-
Tykkfilmmaling, high solids, dispersjoner, lateksmaling, fasadebeskyttelse, takmaling	-	-	+	+	+
Rustbeskyttelse, bitumenfarver, tekstillim	-	-	-	-	+
Tyktfl. rustbeskyttelse, Airless sprøyte-sparkel	-	-	-	-	-

+ = egnet; - = ikke egnet

TempSpray H 326, Spraypack	SuperFinish 23 Plus TempSpray på vogn	TempSpray H 126 AirCoat Spraypack
		
		
2311854	2341496	-
DPTS	DPFSS	-
-		-
23 kg	29 kg	3.5 kg
		
230 V / 50 Hz	230 V / 50 Hz	230 V / 50 Hz
6 m	6 m	4 m
1.1 kW	1.3 kW	0.6 kW
30 m	10 m	10 m
250 bar, 25 MPa	250 bar, 25 MPa	250 bar, 25 MPa
20 – 60 °C	20 – 60 °C	20 – 60 °C
25.000 mPas	20.000 mPas	5.000 mPas









TempSpray H 326, Spraypack	SuperFinish 23 Plus TempSpray på vogn	TempSpray H 126 AirCoat Spraypack
-	+	+
+	-	-
+	-	-
-	-	-

6 Byggeplass– Lakk og trebeskyttelse

	FinishControl 3500	FinishControl 5000	FineCoat 9900 Plus	SuperFinish 23 Plus AirCoat På vogn	SuperFinish 23 Plus AirCoat with compressor på vogn
Sprøytemetode					
Produktbilde (kan avvike)					
Art. Nr.	2341501	2316090	276048	2341490	2353393
Kat.	DPXVLP	DPXVLP	DPFC	DPFSF	DPFSF
Teknologi					
Vekt	2,3 kg	8 kg	10 kg	29 kg	42 kg
Motoreffekt	0.7 kW	1.4 kW	1.5 kW	1.3 kW	1.3 kW
Drift					
Spenning	230 V / 50 Hz	230 V / 50 Hz	230 V / 50 Hz	230 V / 50 Hz	230 V / 50 Hz
Maks. dysestørrelse	-	-	-	0.023"	0.023"
Maks. driftstrykk	0.2 bar, 0.02 MPa	0.275 bar, 0.0275 MPa	0.72 bar, 0.072 MPa	250 bar, 25 MPa	250 bar, 25 MPa
Maks. materiale	-	-	-	2.6 l/min	2.6 l/min
Maks. viskositet	-	-	-	20.000 mPas	20.000 mPas

Materiale	FinishControl 3500	FinishControl 5000	FineCoat 9900 Plus	SuperFinish 23 Plus AirCoat	SuperFinish 23 Plus AirCoat med kompressor
Løsemidler, oljer og fett	S	S	S-M	S-M	S-M
lasurer, beis og impregneringsmidler	S	S	S-M	S-M	S-M
Grunninger, primere, fyllstoffer, syntetiske resinbaserte malinger, akrylmaling	S	S	S-M	S-M	S-M

























Egnet for følgende objektstr: S = mindre enn 200 m², M = 200 m² - 800 m², L = over 800 m², - = ikke egnet

Finish 230	SuperFinish 23 Plus Airless lakk* På vogn
	
	
311062	2341492
DPFSF	DPFSF
	
17 kg	29 kg
1.1 kW	1.3 kW
	
230 V / 50 Hz	230 V / 50 Hz
0.019"	0.023"
260 bar, 26 MPa	250 bar, 25 MPa
1.25 l/min	2.6 l/min
-	20.000 mPas

Finish 230	SuperFinish 23 Plus Airless lakk
S	S-M
-	S-M
S	S-M



























7

Tre- og metallarbeid (eksplosjons-beskyttelse)



















	Zip 52 (A) = Alu (B) = rustfritt stål (C) = Acetal ledende	Zip 52 Perfect Flow	Zip 52 Spraypack	Cobra 40-10 AirCoat	SuperFinish 17 ex AirCoat	FineFinish 20-30 S AirCoat (A) = på vogn med beholder (B) = på 4 ben
Sprøytemetode						
Produktbilde (kan avvike)						
Art. Nr.	(A) = 2301832 (B) = 2301836 (C) = 2301837	2301838	2309669	322112	2364967	(A) = 2309799 (B) = 2309802
Kat.	ILCGR	ILCGR	ILCGR	ILGR	ILGR	ILGR
Teknologi						
Vekt	3.8 kg	3.8 kg	3.8 kg	19 kg	15,4 kg	11 kg
Drift						
Maks. dysestørrelse	-	-	-	0.023"	0.017"	0.019"
Maks. driftstrykk	8 bar, 0.8 MPa	8 bar, 0.8 MPa	8 bar, 0.8 MPa	250 bar, 25 MPa	230 bar, 23 MPa	160 bar, 16 MPa
Maks. materiale	52 l/min	52 l/min	52 l/min	2 l/min	1,6 l/min	1.8 l/min
Utvekslingsforhold	1 : 1	1 : 1	1 : 1	40 : 1	-	20 : 1
Luft inngangstrykk	1-8 bar, 0.1-0.8 MPa	1-8 bar, 0.1-0.8 MPa	1-8 bar, 0.1-0.8 MPa	2.5-6 bar, 0.25-0.6 MPa	6-8 bar, 0.6-0.8 MPa	2-8 bar, 0.2-0.8 MPa

Materiale	Zip 52	Zip 52 Perfect Flow	Zip 52 Spraypack	Cobra 40-10 AirCoat	SuperFinish 17 ex AirCoat	FineFinish 20-30 S AirCoat
Løsemidler, oljer og fett	S-L	S-L	S-L	S-L	S-M	S-M
Lasurer, beis og impregneringsmidler	S-L	S-L	S-L	S-L	S-M	S-M
Grunninger, primere, fyllstoffer, syntetiske resin-baserte malinger, akrylmaling	S-L	S-L	S-L	S-L	S-M	S-M
UV- og fuktfølsomme materialer, UV-lakker	S-L	S-L	S-L	S-L	-	-

Egnet for følgende objektstr.: S = mindre enn 200 m², M = 200 m² - 800 m², L = over 800 m², - = ikke egnet









FineFinish 40-15 Compact	Wildcat 18-40 AirCoat (A) = på 4 ben (B) = med beholder (C) = på vogn	Wildcat 18-40 on wall mount	Puma 28-40 AirCoat (A) = på 4 ben (B) = på vogn	Puma 28-40 veggmontert	FineFinish 40-15 S Airless på 4 ben	Puma 28-40 Airless på 4 ben
		-		-		
						
2363202	(A) = 366127 (B) = 366126 (C) = 366125	2301851	(A) = 367168 (B) = 367167	2301854	2309804	2303397
ILGR	ILGR	ILGR	ILGR	ILGR	ILGR	ILGR
						
17 kg	15 kg	15 kg	16 kg	16 kg	9 kg	16 kg
						
-	0.019"	0.019"	0.023"	0.023"	0.013"	0.023"
280 bar, 28 MPa	144 bar, 14.4 MPa	144 bar, 14.4 MPa	224 bar, 22.4 MPa	224 bar, 22.4 MPa	250 bar, 25 MPa	224 bar, 22.4 MPa
-	2.4 l/min	2.4 l/min	2.4 l/min	2.4 l/min	0.9 l/min	2.4 l/min
40 : 1	18 : 1	18 : 1	28 : 1	28 : 1	40 : 1	28 : 1
2-7 bar, 0.2-0.7 MPa	2.5-8 bar, 0.25-0.8 MPa	2.5-8 bar, 0.25-0.8 MPa	2.5-8 bar, 0.25-0.8 MPa	2.5-8 bar, 0.25-0.8 MPa	2-8 bar, 0.2-0.8 MPa	2-8 bar, 0.2-0.8 MPa
FineFinish 40-15 Compact	Wildcat 18-40 AirCoat	Wildcat 18-40 veggmontert	Puma 28-40 AirCoat	Puma 28-40 veggmontert	FineFinish 40-15 S Airless	Puma 28-40 Airless
S-M	S-L	S-L	S-L	S-L	S-M	S-L
S-M	M-L	M-L	M-L	M-L	S-M	M-L
S-M	S-L	S-L	S-L	S-L	S-M	S-L
-	-	-	-	-	-	-

8 Korrosjons- og bygningsbeskyttelse

	SuperFinish 23i	HeavyCoat 750 E	HeavyCoat 750 G	HeavyCoat 950 E	HeavyCoat 950 G
Sprøytemetode	Injection				
Produktbilde (kan avvike)					
Art. Nr.	2361599	2371027	2371029	2332184	2332186
Kat.	DPFSF	DPHC	DPHC	DPHC	DPHC
Teknologi					
Vekt	29 kg	85 kg	81 kg	76 kg	76 kg
Motoreffekt	1.3 kW	3.1 kW	4.1 kW	4.1 kW	4.1 kW
Drift					
Spenning	230 V / 50 Hz	230 V / 50 Hz	–	230 V / 50 Hz	–
Maks. dysestørrelse	0.023"	0.043"	0.043"	0.052"	0.052"
Maks. driftstrykk	250 bar, 25 MPa	250 bar, 25 MPa	250 bar, 25 MPa	250 bar, 25 MPa	250 bar, 25 MPa
Maks. materiale	2.6 l/min	6 l/min	7.6 l/min	8 l/min	8 l/min
Maks. viskositet	20.000 mPas	50.000 mPas	65.000 mPas	50.000 mPas	50.000 mPas

Materiale	SuperFinish 23i	HeavyCoat 750 E	HeavyCoat 750 G	HeavyCoat 950 E	HeavyCoat 950 G
Injeksjoner med epoxy og polyurethan (PU), SPUR skum, vannholdige oppløsninger	S-L	-	-	-	-
Epoxy maling, akrylmaling, grunning og polyurethane	-	M	M	S-M	S-M
Brannhemmende matr., zinkstøv maling, silikon/takmaling	-	M	M	S-M	S-M

Egnet for følgende objektstr.: S = mindre enn 200 m², M = 200 m² - 800 m², L = over 800 m², - = ikke egnet

HeavyCoat 970 E	HeavyCoat 970 G
	
	
2332191	2332192
DPHC	DPHC
	
100 kg	88 kg
5.5 kW	6 kW
	
400 V / 50 Hz	–
0.056"	0.056"
250 bar, 25 MPa	250 bar, 25 MPa
10 l/min	12 l/min
65.000 mPas	65.000 mPas

HeavyCoat 970 E	HeavyCoat 970 G
-	-
S-L	S-L
S-L	S-L

Notes

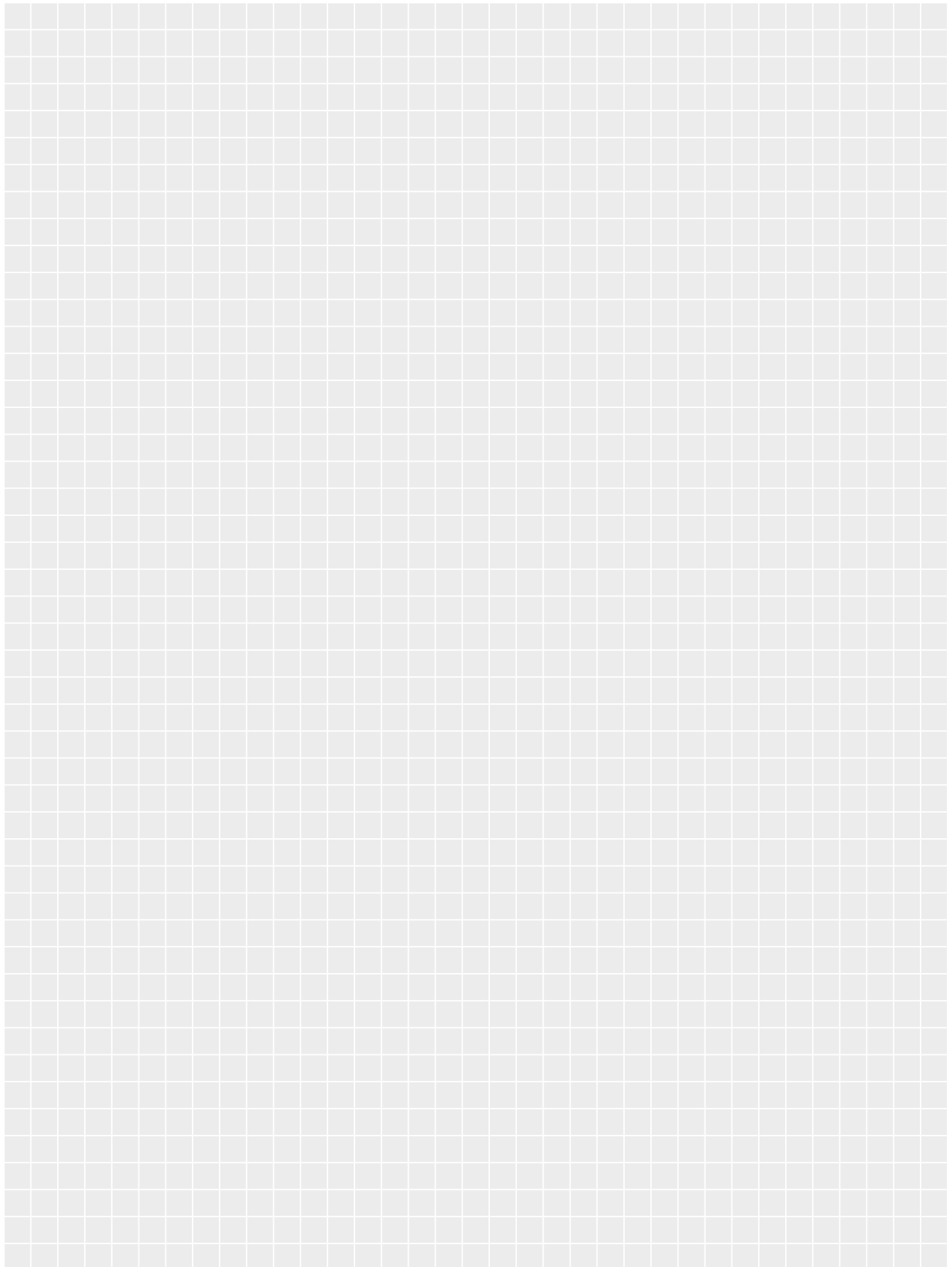

Notes

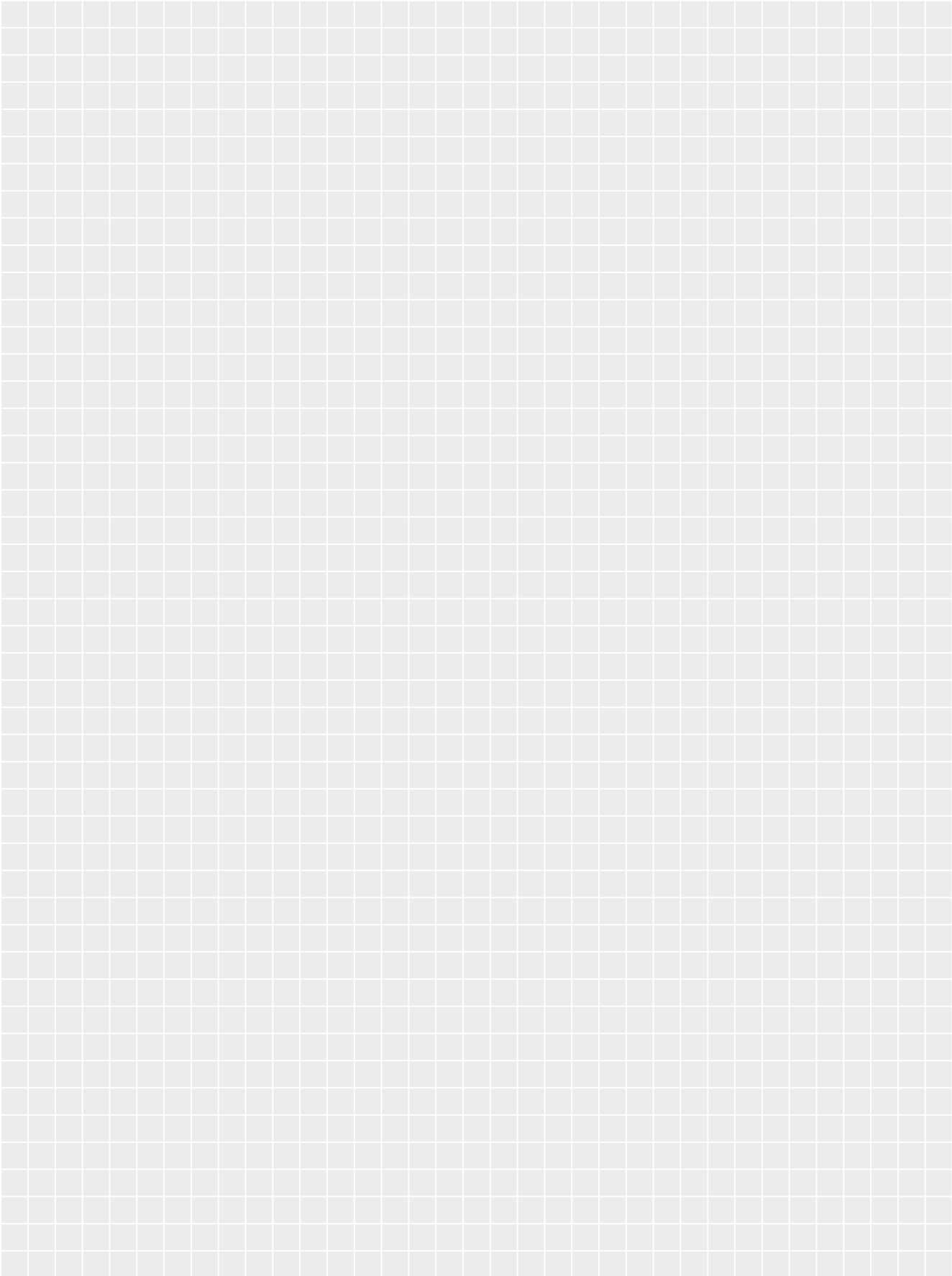



DURI FAGPROFIL AS
Brobekkveien 80C
0582 Oslo
Tlf.: +47 24 13 13 50
E-post: ordrekontor@fagprofil.no

Subject to modifications
NOR - 06/2019 M
2404076

wagner-group.com